

- ① Series name
- ② Output wattage
- ③ UL recognized, TÜV approved, CSA certified: E
- ④ Output voltage
- ⑤ Optional
 C :with Coating
 G :Low leakage current
 J :Connector type
 N :with Cover

MODEL	P15E-5	P15E-9	P15E-12	P15E-15	P15E-18	P15E-24	P15E-30	P15E-48
MAX OUTPUT WATTAGE[W]	15	15.3	15.6	15	16.2	16.8	15	16.8
DC OUTPUT	5V 3A	9V 1.7A	12V 1.3A	15V 1A	18V 0.9A	24V 0.7A	30V 0.5A	48V 0.35A

SPECIFICATIONS

MODEL	P15E-5	P15E-9	P15E-12	P15E-15	P15E-18	P15E-24	P15E-30	P15E-48		
INPUT	VOLTAGE[V]	AC85 - 264 1φ or DC110 - 370								
	CURRENT[A]	0.3typ (Io=100%)								
		0.18typ (Io=100%)								
	FREQUENCY[Hz]	47 - 440 or DC								
	EFFICIENCY[%]	73typ	75typ	79typ	81typ	81typ	81typ	81typ	81typ	
	INRUSH CURRENT[A]	20typ (Io=100%) (At cold start)								
40typ (Io=100%) (At cold start)										
OUTPUT	VOLTAGE[V]	5	9	12	15	18	24	30	48	
	CURRENT[A]	3.0	1.7	1.3	1.0	0.9	0.7	0.5	0.35	
	MAX OUTPUT WATTAGE[W]	15.0	15.3	15.6	15.0	16.2	16.8	15.0	16.8	
	LINE REGULATION[mV]	20max	36max	48max	60max	72max	96max	120max	192max	
	LOAD REGULATION[mV]	40max	70max	100max	120max	140max	150max	180max	380max	
	RIPPLE[mVp-p]	*2 80max	120max	120max	120max	120max	120max	120max	150max	
	RIPPLE NOISE[mVp-p]	*2 120max	150max	150max	150max	150max	150max	150max	250max	
	TEMPERATURE REGULATION[mV]	0 to +50°C	50max	90max	120max	150max	180max	240max	300max	480max
	OUTPUT VOLTAGE ADJUSTMENT RANGE[V]	± 10%								
	START-UP TIME[ms]	100max (ACIN 85V, Io=100%)								
HOLD-UP TIME[ms]	10typ (ACIN 85V, Io=100%) 20typ (ACIN 100V, Io=100%)									
PROTECTION CIRCUIT	OVERCURRENT PROTECTION	Works over 105% of rating and recovers automatically								
	OVERVOLTAGE PROTECTION	Works at 115 - 140% of rating								
ISOLATION	INPUT-OUTPUT	AC3,000V 1minute, Cutoff current = 10mA, DC500V 50MΩmin (At Room Temperature)								
	INPUT-FG	AC2,000V 1minute, Cutoff current = 10mA, DC500V 50MΩmin (At Room Temperature)								
	OUTPUT-FG	AC500V 1minute, Cutoff current = 100mA, DC500V 50MΩmin (At Room Temperature)								
ENVIRONMENT	OPERATING TEMP., HUMID. AND ALTITUDE	-10 to +65°C, 30 - 90%RH (Non condensing) (Refer to DERATING CURVE), 3,000m (10,000feet) max								
	STORAGE TEMP., HUMID. AND ALTITUDE	-20 to +75°C, 20 - 90%RH (Non condensing), 9,000m (30,000feet) max								
	VIBRATION	10 - 55Hz, 19.6m/s ² (2G), 3minutes period, 30minutes each along X, Y and Z axis								
	IMPACT	196.1m/s ² (20G), 11ms, once each X, Y and Z axis								
SAFETY AND NOISE REGULATIONS	AGENCY APPROVALS	UL60950-1, EN60950-1, EN50178, CSA C22.2 No.234 Complies with DEN-AN and IEC60950-1								
	CONDUCTED NOISE	Complies with FCC-B								

*1 The input current of the agency approved unit is indicated as 0.4A.
 *2 According to 15MHz oscilloscope or Ripple-Noise meter (equivalent to KEISOKU-GIKEN : RM101).
 * Derating is required when operated with case cover.
 * Parallel operation with other model is not possible.

External view

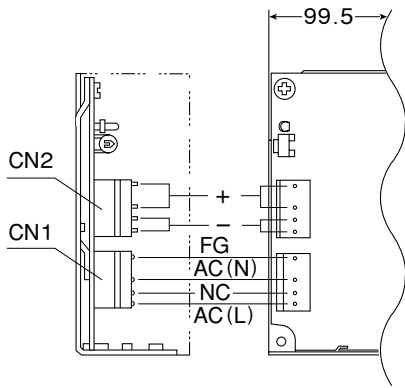

I/O Connector	Mating Connector	Terminal
CN1	5289-4A	5199-04
		Chain: 5194PBT
		Loose: 5194PBT
CN2	5277-4A	5196-04
		Chain: 5194PBT
		Loose: 5194PBT

(Mfr : Molex)

Connector type

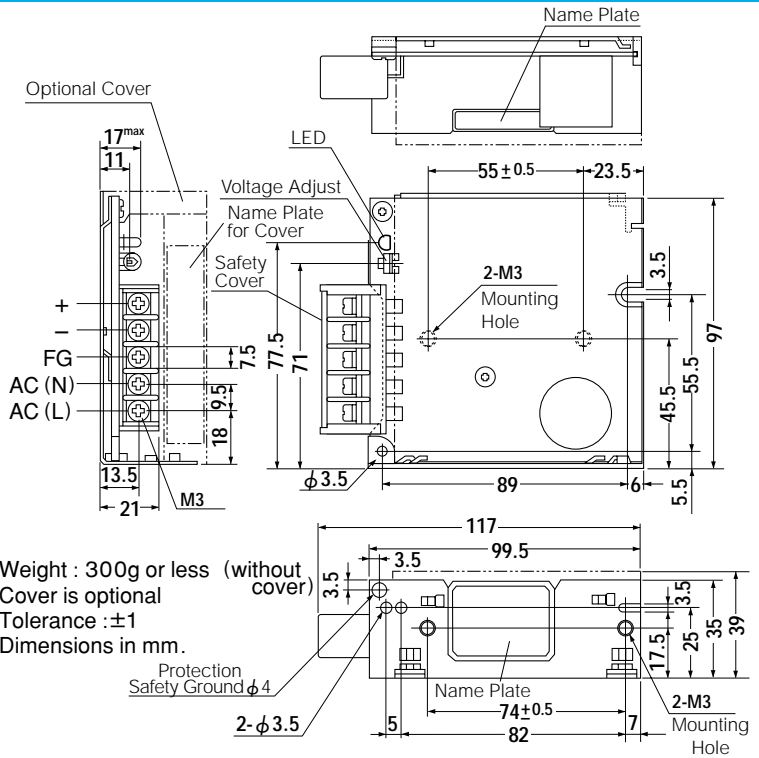

- ※Weight : 300g or less (without cover)
- ※Cover is optional
- ※Tolerance : ±1
- ※Dimensions in mm.

※Mounting torque: 0.6N·m (6.3kgf·cm) max

Barrier strip type

Performance data

■ STATIC CHARACTERISTICS (P15E-5)

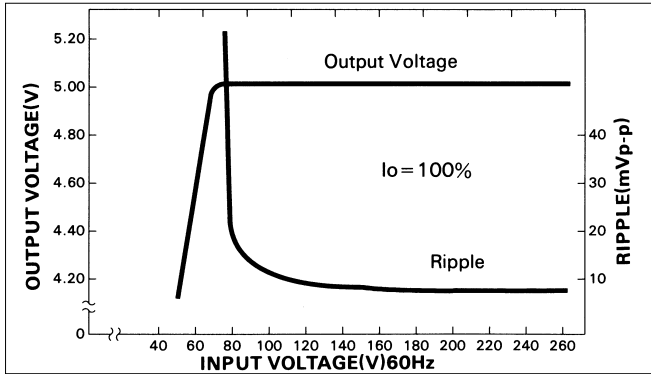

■ RISE TIME & FALL TIME (P15E-5)

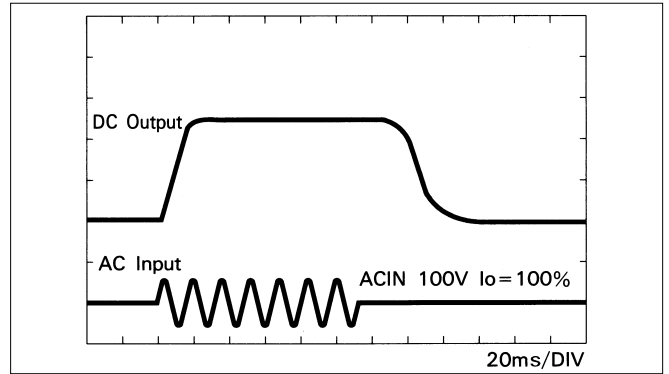

■ OVERCURRENT CHARACTERISTICS (P15E-5)

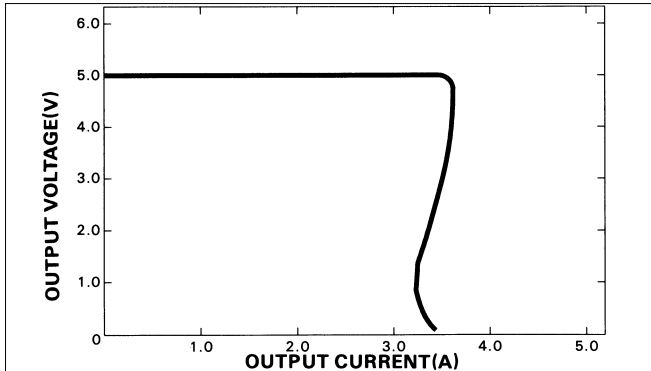

■ DERATING CURVE

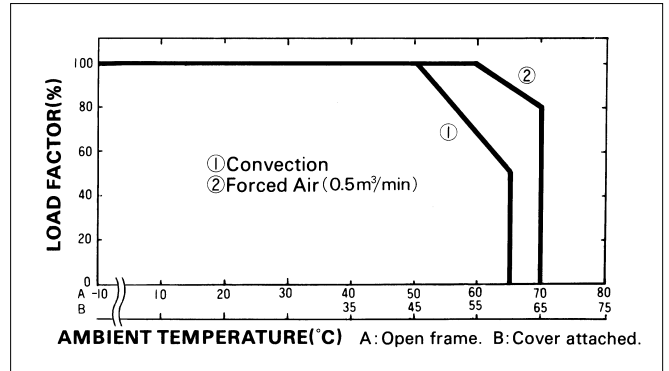

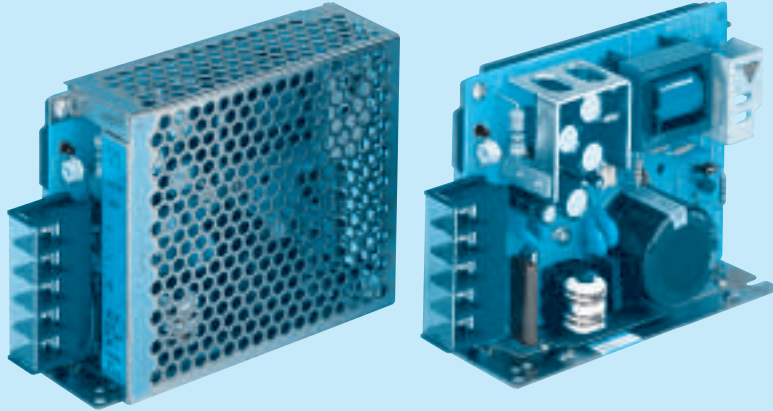

- ① Series name
- ② Output wattage
- ③ UL recognized, TÜV approved, CSA certified: E
- ④ Output voltage
- ⑤ Optional
 C : with Coating
 G : Low leakage current
 J : Connector type
 N : with Cover

MODEL	P30E-5	P30E-9	P30E-12	P30E-15	P30E-18	P30E-24	P30E-30	P30E-48
MAX OUTPUT WATTAGE[W]	30	30.6	30	30	30.6	31.2	30	30.24
DC OUTPUT	5V 6A	9V 3.4A	12V 2.5A	15V 2A	18V 1.7A	24V 1.3A	30V 1.0A	48V 0.63A

SPECIFICATIONS

MODEL	P30E-5	P30E-9	P30E-12	P30E-15	P30E-18	P30E-24	P30E-30	P30E-48
INPUT								
VOLTAGE[V]	AC85 - 264 1φ or DC110 - 370							
CURRENT[A]	ACIN 100V *1	0.6typ (Io=100%)						
	ACIN 200V *1	0.35typ (Io=100%)						
FREQUENCY[Hz]	47 - 440 or DC							
EFFICIENCY[%]	74typ	74typ	78typ	79typ	79typ	82typ	82typ	82typ
INRUSH CURRENT[A]	ACIN 100V	20typ (Io=100%) (At cold start)						
	ACIN 200V	40typ (Io=100%) (At cold start)						
OUTPUT								
VOLTAGE[V]	5	9	12	15	18	24	30	48
CURRENT[A]	6.0	3.4	2.5	2.0	1.7	1.3	1.0	0.63
MAX OUTPUT WATTAGE[W]	30	30.6	30	30	30.6	31.2	30	30.24
LINE REGULATION[mV]	20max	36max	48max	60max	72max	96max	120max	192max
LOAD REGULATION[mV]	40max	70max	100max	120max	140max	150max	180max	300max
RIPPLE[mVp-p] *2	80max	120max	120max	120max	120max	120max	120max	150max
RIPPLE NOISE[mVp-p] *2	120max	150max	150max	150max	150max	150max	150max	250max
TEMPERATURE REGULATION[mV] 0 to +50°C	50max	90max	120max	150max	180max	240max	300max	480max
OUTPUT VOLTAGE ADJUSTMENT RANGE[V]	± 10%							
START-UP TIME[ms]	100max (ACIN 85V, Io=100%)							
HOLD-UP TIME[ms]	10typ (ACIN 85V, Io=100%) 20typ (ACIN 100V, Io=100%)							
PROTECTION CIRCUIT								
OVERCURRENT PROTECTION	Works over 105% of rating and recovers automatically							
OVERVOLTAGE PROTECTION	Works at 115 - 140% of rating							
ISOLATION								
INPUT-OUTPUT	AC3,000V 1minute, Cutoff current = 10mA, DC500V 50MΩmin (At Room Temperature)							
INPUT-FG	AC2,000V 1minute, Cutoff current = 10mA, DC500V 50MΩmin (At Room Temperature)							
OUTPUT-FG	AC500V 1minute, Cutoff current = 100mA, DC500V 50MΩmin (At Room Temperature)							
ENVIRONMENT								
OPERATING TEMP., HUMID. AND ALTITUDE	-10 to +65°C, 30 - 90%RH (Non condensing) (Refer to DERATING CURVE), 3,000m (10,000feet) max							
STORAGE TEMP., HUMID. AND ALTITUDE	-20 to +75°C, 20 - 90%RH (Non condensing), 9,000m (30,000feet) max							
VIBRATION	10 - 55Hz, 19.6m/s ² (2G), 3minutes period, 30minutes each along X, Y and Z axis							
IMPACT	196.1m/s ² (20G), 11ms, once each X, Y and Z axis							
SAFETY AND NOISE REGULATIONS								
AGENCY APPROVALS	UL60950-1, EN60950-1, EN50178, CSA C22.2 No.234 Complies with DEN-AN and IEC60950-1							
CONDUCTED NOISE	Complies with FCC-B							

*1 The input current of the agency approved unit is indicated as 0.7A.
 *2 According to 15MHz oscilloscope or Ripple-Noise meter (equivalent to KEISOKU-GIKEN : RM101).
 * Derating is required when operated with case cover.
 * Parallel operation with other model is not possible.

External view

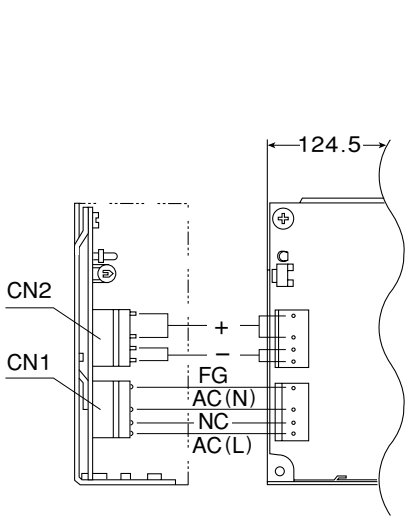

I/O Connector	Mating Connector	Terminal
CN1 5289-4A	5199-04	Chain: 5194PBT Loose: 5194PBT
CN2 5277-4A	5196-04	Chain: 5194PBT Loose: 5194PBT

(Mfr: Molex)

Connector type

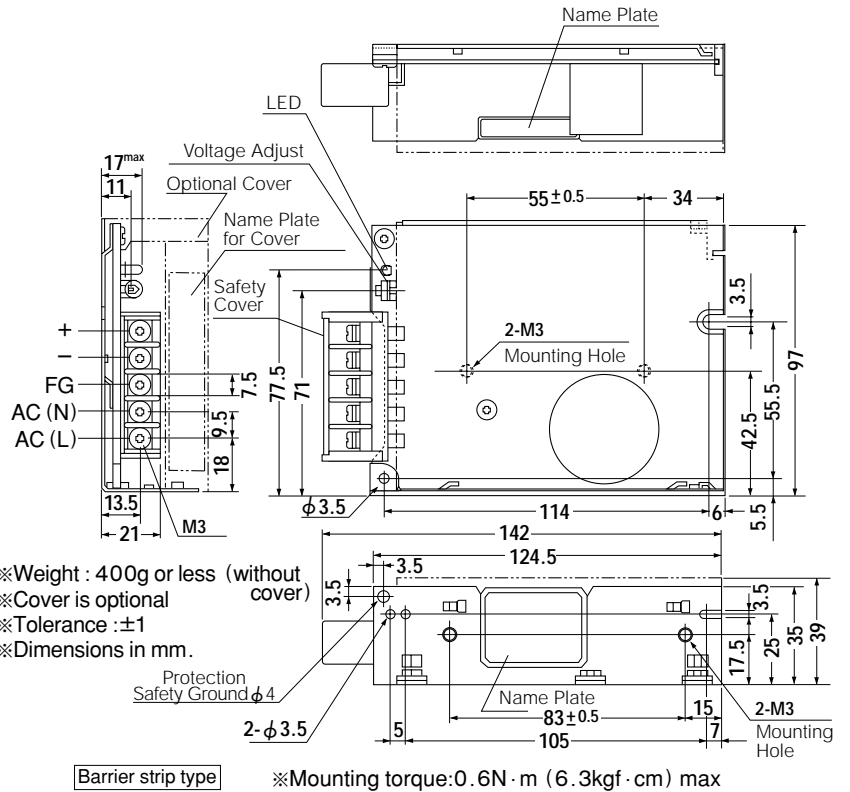

Barrier strip type

Performance data

■ STATIC CHARACTERISTICS (P30E-5)

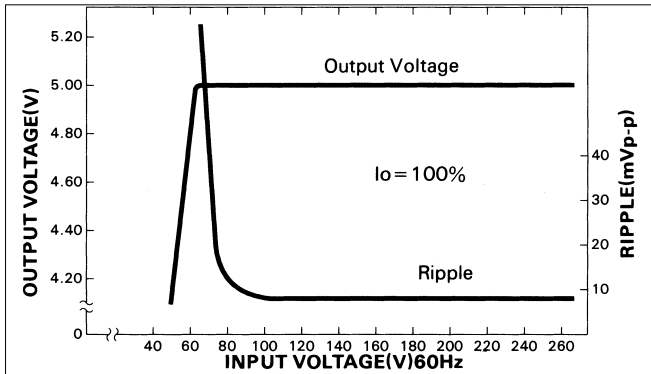

■ RISE TIME & FALL TIME (P30E-5)

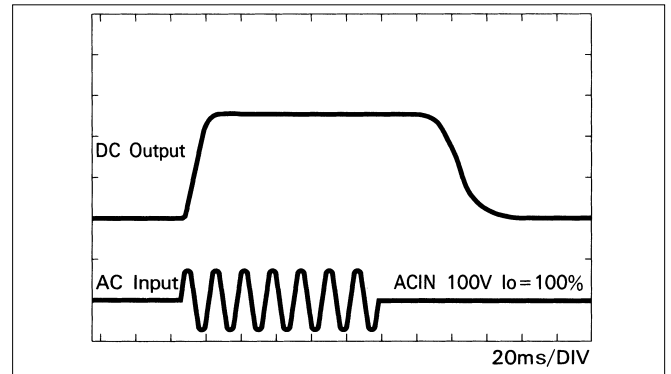

■ OVERCURRENT CHARACTERISTICS (P30E-5)

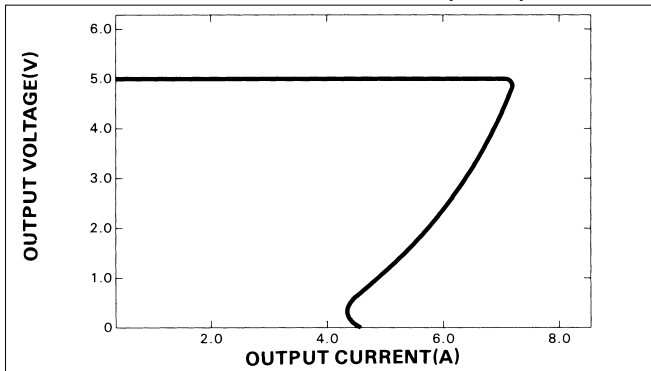

■ DERATING CURVE

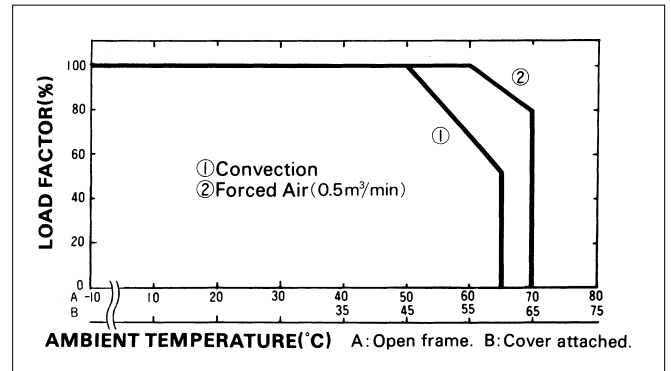

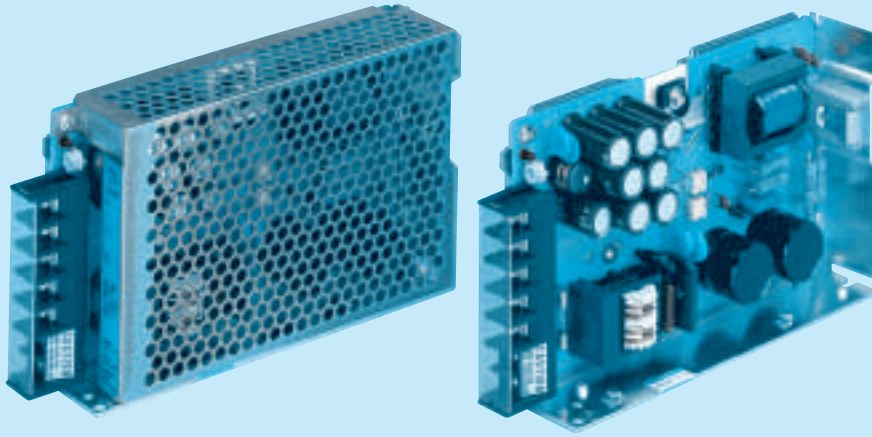

- ① Series name
- ② Output wattage
- ③ UL recognized, TÜV approved, CSA certified: E
- ④ Output voltage
- ⑤ Optional
 C : with Coating
 G : Low leakage current
 J : Connector type
 N : with Cover

MODEL	P50E-5	P50E-9	P50E-12	P50E-15	P50E-18	P50E-24	P50E-30	P50E-48
MAX OUTPUT WATTAGE[W]	50	49.5	50.4	51	50.4	50.4	51	48
DC OUTPUT	5V 10A	9V 5.5A	12V 4.2A	15V 3.4A	18V 2.8A	24V 2.1A	30V 1.7A	48V 1.0A

SPECIFICATIONS

MODEL	P50E-5	P50E-9	P50E-12	P50E-15	P50E-18	P50E-24	P50E-30	P50E-48
INPUT	AC85 - 132 / 170 - 264 1 φ (User-selectable) or DC220 - 370							
CURRENT[A]	ACIN 100V *1 1.2typ (Io=100%) ACIN 200V *1 0.61typ (Io=100%)							
FREQUENCY[Hz]	47 - 440							
EFFICIENCY[%]	72typ	77typ	77typ	78typ	78typ	80typ	82typ	80typ
INRUSH CURRENT[A]	ACIN 100V 20typ (Io=100%) (At cold start) ACIN 200V 40typ (Io=100%) (At cold start)							
OUTPUT	5	9	12	15	18	24	30	48
CURRENT[A]	10	5.5	4.2	3.4	2.8	2.1	1.7	1.0
MAX OUTPUT WATTAGE[W]	50	49.5	50.4	51	50.4	50.4	51	48
LINE REGULATION[mV]	20max	36max	48max	60max	72max	96max	120max	192max
LOAD REGULATION[mV]	40max	70max	100max	120max	144max	150max	180max	240max
RIPPLE[mVp-p] *2	80max	120max	120max	120max	120max	120max	120max	150max
RIPPLE NOISE[mVp-p] *2	120max	150max	150max	150max	150max	150max	150max	250max
TEMPERATURE REGULATION[mV] 0 to +50°C	50max	120max	120max	150max	180max	240max	350max	480max
OUTPUT VOLTAGE ADJUSTMENT RANGE[V]	± 10%							
START-UP TIME[ms]	100max (ACIN 85V, Io=100%)							
HOLD-UP TIME[ms]	10typ (ACIN 85V, Io=100%) 20typ (ACIN 100V, Io=100%)							
PROTECTION CIRCUIT	OVERCURRENT PROTECTION Works over 105% of rating and recovers automatically OVERVOLTAGE PROTECTION Works at 115 - 140% of rating							
ISOLATION	INPUT-OUTPUT AC3,000V 1minute, Cutoff current = 10mA, DC500V 50MΩmin (At Room Temperature) INPUT-FG AC2,000V 1minute, Cutoff current = 10mA, DC500V 50MΩmin (At Room Temperature) OUTPUT-FG AC500V 1minute, Cutoff current = 100mA, DC500V 50MΩmin (At Room Temperature)							
ENVIRONMENT	OPERATING TEMP., HUMID. AND ALTITUDE -10 to +65°C, 30 - 90%RH (Non condensing) (Refer to DERATING CURVE), 3,000m (10,000feet) max STORAGE TEMP., HUMID. AND ALTITUDE -20 to +75°C, 20 - 90%RH (Non condensing), 9,000m (30,000feet) max VIBRATION 10 - 55Hz, 19.6m/s ² (2G), 3minutes period, 30minutes each along X, Y and Z axis IMPACT 196.1m/s ² (20G), 11ms, once each X, Y and Z axis							
SAFETY AND NOISE REGULATIONS	AGENCY APPROVALS UL60950-1, EN60950-1, EN50178, CSA C22.2 No.234 Complies with DEN-AN and IEC60950-1 CONDUCTED NOISE Complies with FCC-B							

*1 The input current of the agency approved unit is indicated as 1.1A (ACIN 100V) or 0.6A (ACIN 200V).
 *2 According to 15MHz oscilloscope or Ripple-Noise meter (equivalent to KEISOKU-GIKEN : RM101).
 * Derating is required when operated with case cover.
 * Parallel operation with other model is not possible.

External view

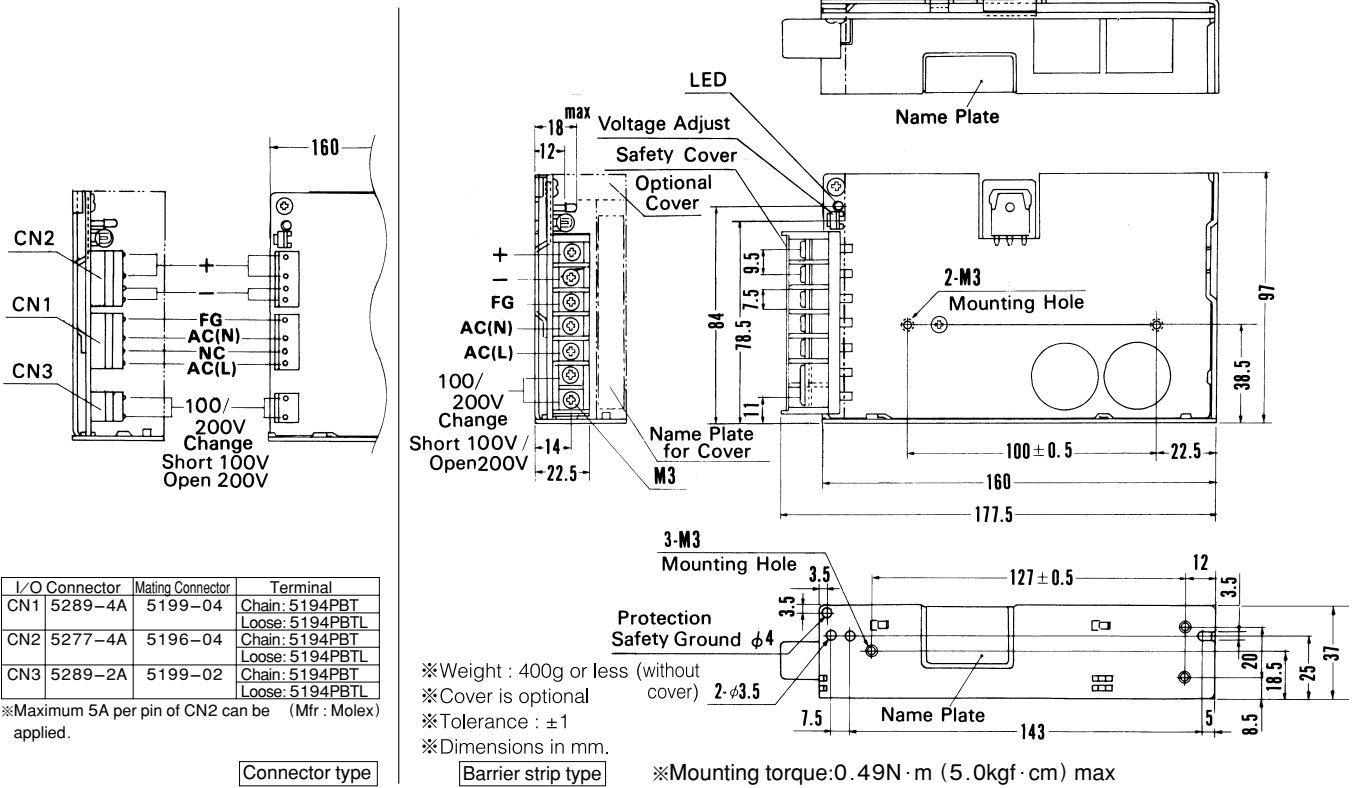

Performance data

■ STATIC CHARACTERISTICS (P50E-5)

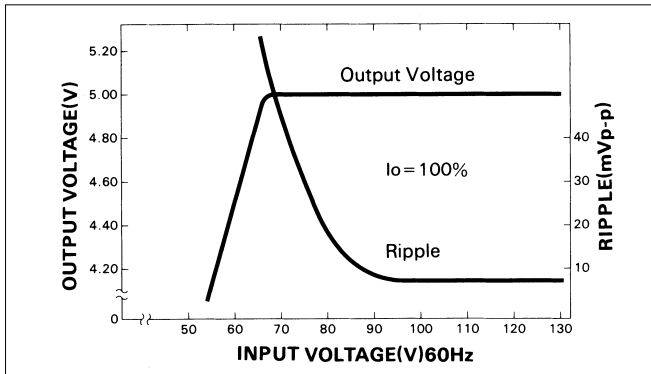

■ RISE TIME & FALL TIME (P50E-5)

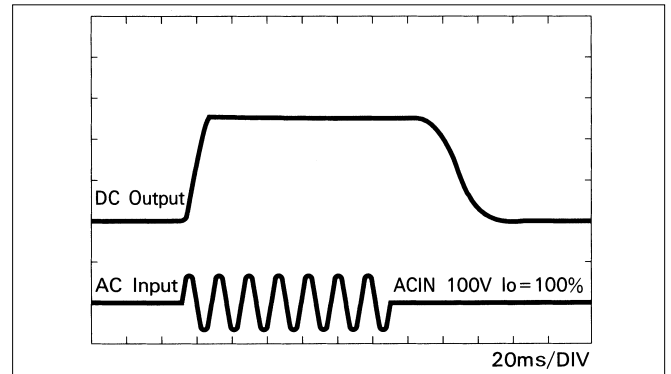

■ OVERCURRENT CHARACTERISTICS (P50E-5)

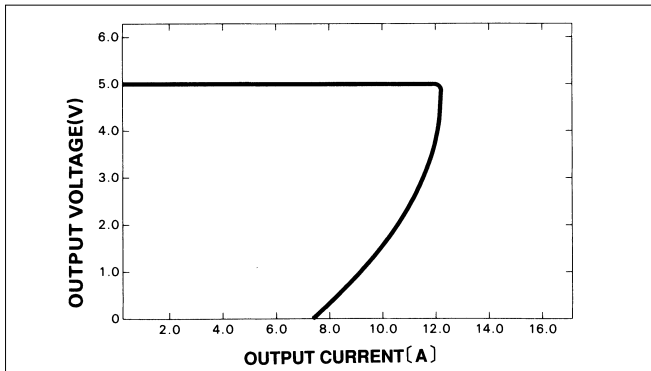

■ DERATING CURVE

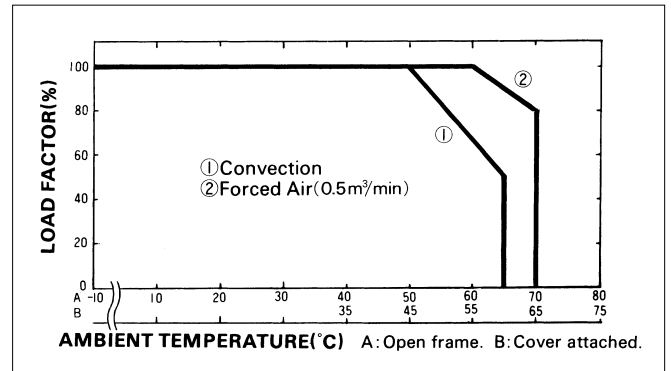

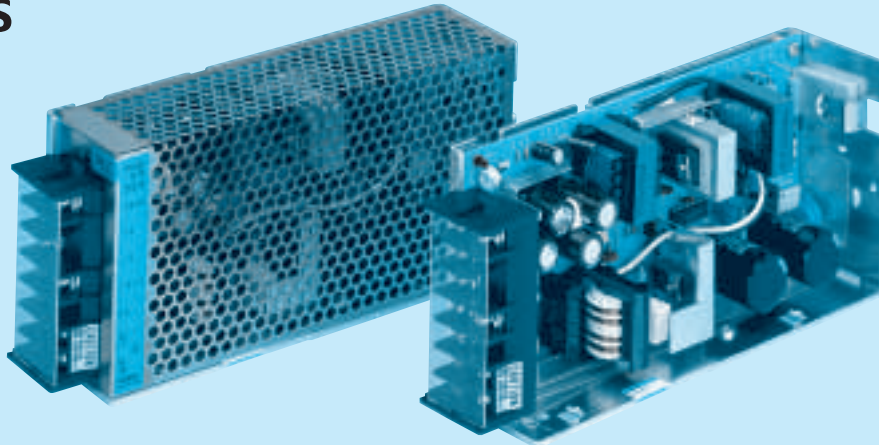

- ① Series name
- ② Output wattage
- ③ UL recognized, TÜV approved, CSA certified: E
- ④ Output voltage
- ⑤ Optional
C : with Coating
G : Low leakage current
N : with Cover

MODEL	P100E-5	P100E-9	P100E-12	P100E-15	P100E-18	P100E-24	P100E-30	P100E-48
MAX OUTPUT WATTAGE[W]	100	100.8	102	105	100.8	108	99	100.8
DC OUTPUT	5V 20A	9V 11.2A	12V 8.5A	15V 7A	18V 5.6A	24V 4.5A	30V 3.3A	48V 2.1A

SPECIFICATIONS

	MODEL	P100E-5	P100E-9	P100E-12	P100E-15	P100E-18	P100E-24	P100E-30	P100E-48	
INPUT	VOLTAGE[V]	AC85 - 132 / 170 - 264 1 φ (User-selectable) or DC220 - 370								
	CURRENT[A]	ACIN 100V *1	2.2typ (Io=100%)							
		ACIN 200V *1	1.2typ (Io=100%)							
	FREQUENCY[Hz]	47 - 440								
	EFFICIENCY[%]		78typ	78typ	80typ	82typ	82typ	84typ	78typ	84typ
	INRUSH CURRENT[A]	ACIN 100V	15typ (Io=100%)							
ACIN 200V		30typ (Io=100%)								
OUTPUT	VOLTAGE[V]	5	9	12	15	18	24	30	48	
	CURRENT[A]	20	11.2	8.5	7	5.6	4.5	3.3	2.1	
	MAX OUTPUT WATTAGE[W]	100	100.8	102	105	100.8	108	99	100.8	
	LINE REGULATION[mV]	20max	36max	48max	60max	72max	96max	120max	192max	
	LOAD REGULATION[mV]	40max	72max	100max	120max	150max	150max	180max	384max	
	RIPPLE[mVp-p] *2	80max	120max	120max	120max	120max	120max	120max	150max	
	RIPPLE NOISE[mVp-p] *2	120max	150max	150max	150max	250max	150max	150max	250max	
	TEMPERATURE REGULATION[mV] 0 to +50°C	50max	90max	120max	150max	180max	240max	300max	480max	
	OUTPUT VOLTAGE ADJUSTMENT RANGE[V]	± 10%								
	START-UP TIME[ms]	200max (ACIN 85V, Io=100%)								
HOLD-UP TIME[ms]	15typ (ACIN 85V, Io=100%) 25typ (ACIN 100V, Io=100%)									
PROTECTION CIRCUIT	OVERCURRENT PROTECTION	Works over 105% of rating and recovers automatically								
	OVERVOLTAGE PROTECTION	Works at 115 - 140% of rating								
ISOLATION	INPUT-OUTPUT	AC3,000V 1minute, Cutoff current = 10mA, DC500V 50MΩmin (At Room Temperature)								
	INPUT-FG	AC2,000V 1minute, Cutoff current = 10mA, DC500V 50MΩmin (At Room Temperature)								
	OUTPUT-FG	AC500V 1minute, Cutoff current = 100mA, DC500V 50MΩmin (At Room Temperature)								
ENVIRONMENT	OPERATING TEMP., HUMID. AND ALTITUDE	-10 to +65°C, 30 - 90%RH (Non condensing) (Refer to DERATING CURVE), 3,000m (10,000feet) max								
	STORAGE TEMP., HUMID. AND ALTITUDE	-20 to +75°C, 20 - 90%RH (Non condensing), 9,000m (30,000feet) max								
	VIBRATION	10 - 55Hz, 19.6m/s ² (2G), 3minutes period, 30minutes each along X, Y and Z axis								
	IMPACT	196.1m/s ² (20G), 11ms, once each X, Y and Z axis								
SAFETY AND NOISE REGULATIONS	AGENCY APPROVALS	UL60950-1, EN60950-1, EN50178, CSA C22.2 No.234 Complies with DEN-AN and IEC60950-1								
	CONDUCTED NOISE	Complies with FCC-A								

*1 The input current of the agency approved unit is indicated as 2.5A (ACIN100V) or 1.5A (ACIN200V).
 *2 According to 15MHz oscilloscope or Ripple-Noise meter (equivalent to KEISOKU-GIKEN : RM101).
 * Derating is required when operated with case cover.
 * Parallel operation with other model is not possible.

External view

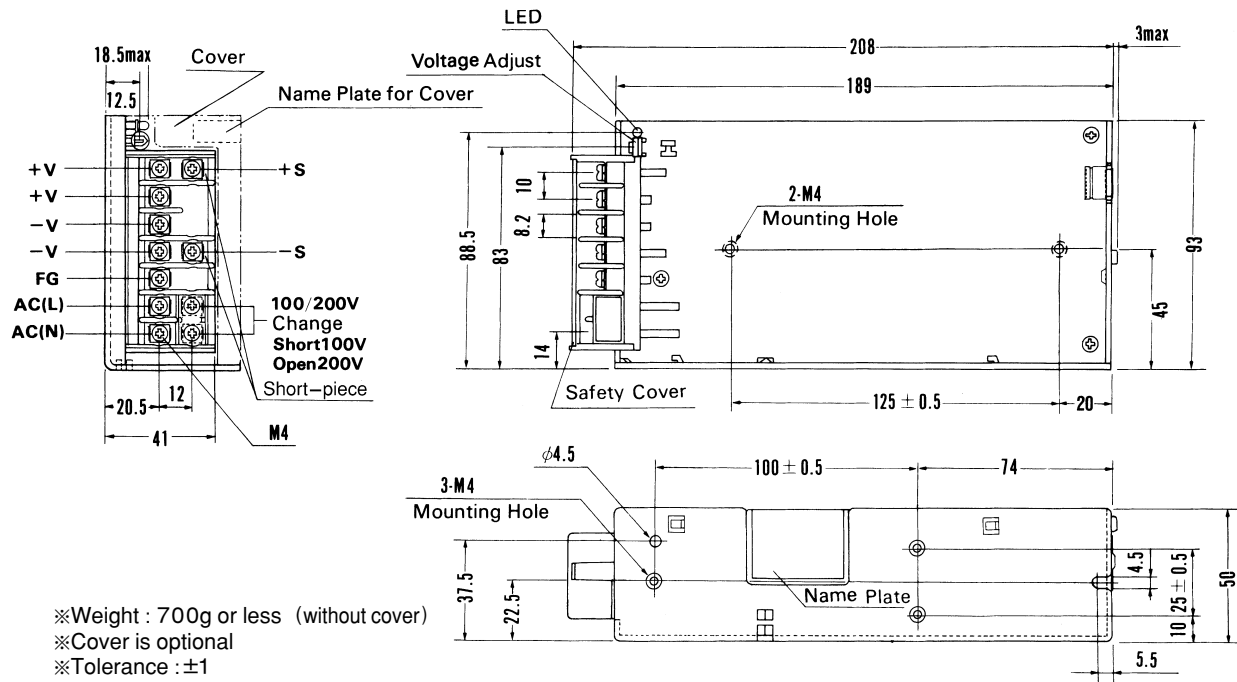

- ※Weight : 700g or less (without cover)
- ※Cover is optional
- ※Tolerance : ±1
- ※Dimensions in mm.
- ※Mounting torque: 1.2N · m (12.8kgf · cm) max

Performance data

■ STATIC CHARACTERISTICS (P100E-5)

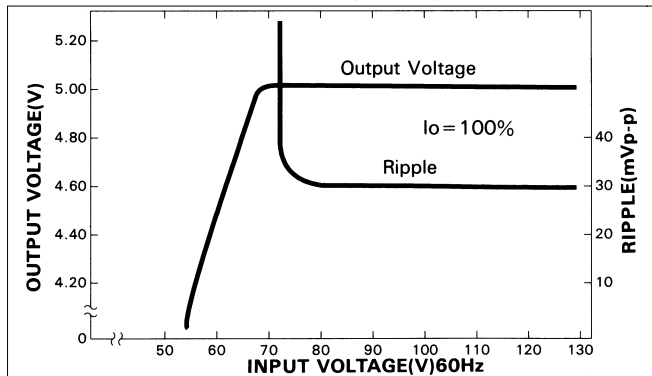

■ RISE TIME & FALL TIME (P100E-5)

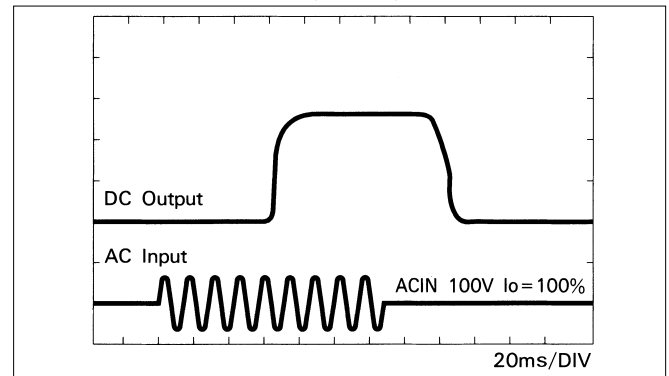

■ OVERCURRENT CHARACTERISTICS (P100E-5)

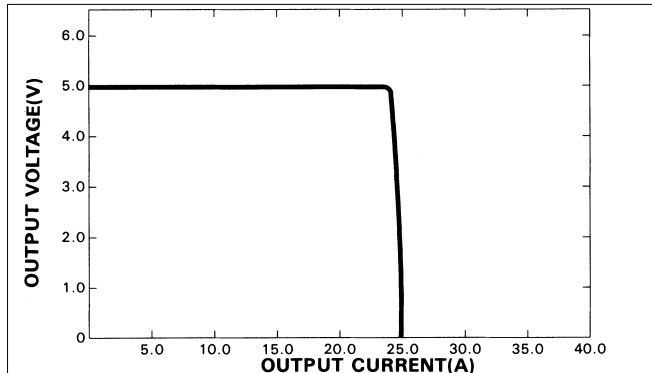

■ DERATING CURVE

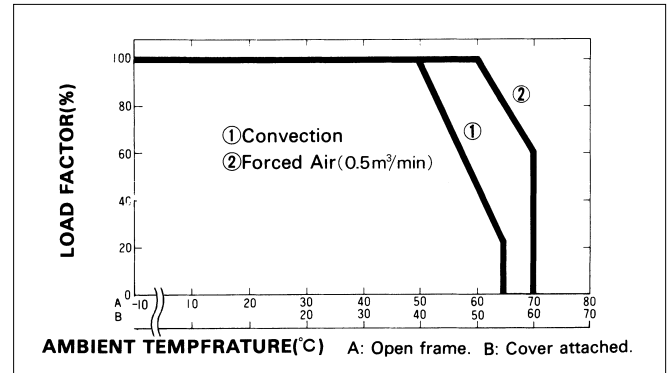

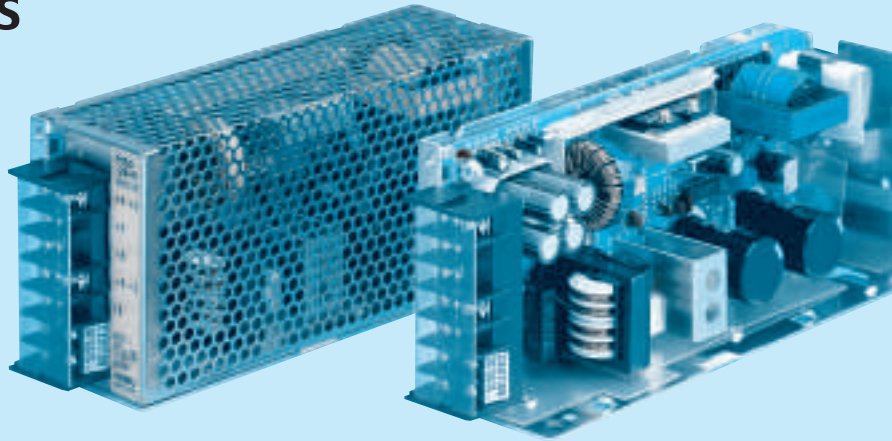

- ① Series name
- ② Output wattage
- ③ UL recognized, TÜV approved, CSA certified: E
- ④ Output voltage
- ⑤ Optional
C : with Coating
G : Low leakage current
N : with Cover

MODEL	P150E-5	P150E-9	P150E-12	P150E-15	P150E-18	P150E-24	P150E-30	P150E-48
MAX OUTPUT WATTAGE[W]	150	150.3	156	150	151.2	156	150	158.4
DC OUTPUT	5V 30A	9V 16.7A	12V 13A	15V 10A	18V 8.4A	24V 6.5A	30V 5.0A	48V 3.3A

SPECIFICATIONS

	MODEL	P150E-5	P150E-9	P150E-12	P150E-15	P150E-18	P150E-24	P150E-30	P150E-48	
INPUT	VOLTAGE[V]	AC85 - 132 / 170 - 264 1φ (User-selectable) or DC220 - 370								
	CURRENT[A]	ACIN 100V *1	3.2typ (Io=100%)							
		ACIN 200V *1	1.7typ (Io=100%)							
	FREQUENCY[Hz]	47 - 440								
	EFFICIENCY[%]		78typ	78typ	80typ	81typ	82typ	82typ	82typ	85typ
	INRUSH CURRENT[A]	ACIN 100V	15typ (Io=100%)							
ACIN 200V		30typ (Io=100%)								
OUTPUT	VOLTAGE[V]	5	9	12	15	18	24	30	48	
	CURRENT[A]	30	16.7	13	10	8.4	6.5	5.0	3.3	
	MAX OUTPUT WATTAGE[W]	150	150.3	156	150	151.2	156	150	158.4	
	LINE REGULATION[mV]	20max	36max	48max	60max	72max	96max	120max	192max	
	LOAD REGULATION[mV]	40max	72max	100max	120max	150max	150max	190max	240max	
	RIPPLE[mVp-p] *2	80max	120max	120max	120max	120max	120max	150max	150max	
	RIPPLE NOISE[mVp-p] *2	120max	150max	150max	150max	250max	150max	180max	200max	
	TEMPERATURE REGULATION[mV] 0 to +50°C	50max	90max	120max	150max	180max	240max	300max	480max	
	OUTPUT VOLTAGE ADJUSTMENT RANGE[V]	± 10%								
	START-UP TIME[ms]	200max (ACIN 85V, Io=100%)								
HOLD-UP TIME[ms]	15typ (ACIN 85V, Io=100%) 25typ (ACIN 100V, Io=100%)									
PROTECTION CIRCUIT	OVERCURRENT PROTECTION	Works over 105% of rating and recovers automatically								
	OVERVOLTAGE PROTECTION	Works at 115 - 140% of rating								
ISOLATION	INPUT-OUTPUT	AC3,000V 1minute, Cutoff current = 10mA, DC500V 50MΩmin (At Room Temperature)								
	INPUT-FG	AC2,000V 1minute, Cutoff current = 10mA, DC500V 50MΩmin (At Room Temperature)								
	OUTPUT-FG	AC500V 1minute, Cutoff current = 100mA, DC500V 50MΩmin (At Room Temperature)								
ENVIRONMENT	OPERATING TEMP., HUMID. AND ALTITUDE	-10 to +65°C, 30 - 90%RH (Non condensing) (Refer to DERATING CURVE), 3,000m (10,000feet) max								
	STORAGE TEMP., HUMID. AND ALTITUDE	-20 to +75°C, 20 - 90%RH (Non condensing), 9,000m (30,000feet) max								
	VIBRATION	10 - 55Hz, 19.6m/s ² (2G), 3minutes period, 30minutes each along X, Y and Z axis								
	IMPACT	196.1m/s ² (20G), 11ms, once each X, Y and Z axis								
SAFETY AND NOISE REGULATIONS	AGENCY APPROVALS	UL60950-1, EN60950-1, EN50178, CSA C22.2 No.234 Complies with DEN-AN and IEC60950-1								
	CONDUCTED NOISE	Complies with FCC-A								

*1 The input current of the agency approved unit is indicated as 3.5A (ACIN100V) or 1.7A (ACIN200V).
 *2 According to 15MHz oscilloscope or Ripple-Noise meter (equivalent to KEISOKU-GIKEN : RM101).
 * Derating is required when operated with case cover.
 * Parallel operation with other model is not possible.

External view

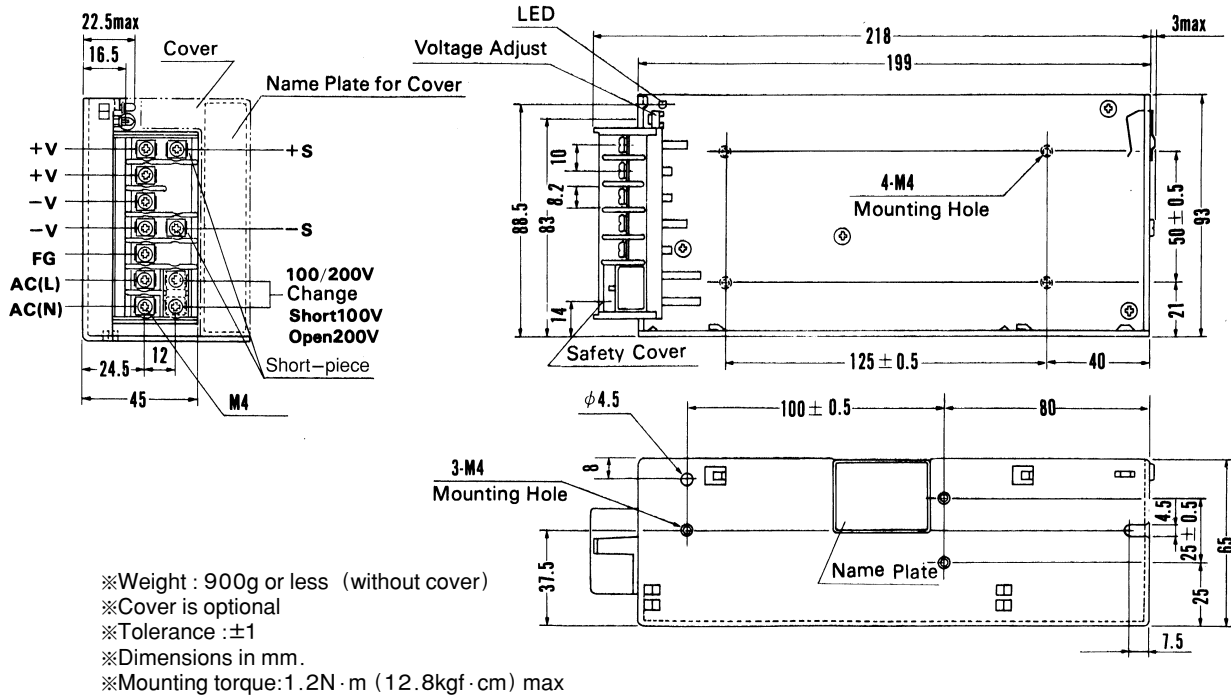

Performance data

■ STATIC CHARACTERISTICS (P150E-5)

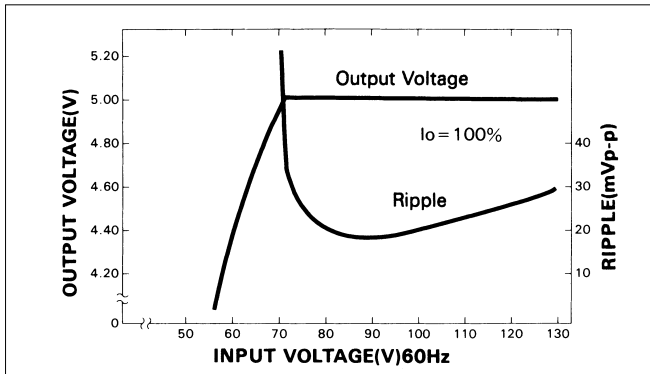

■ RISE TIME & FALL TIME (P150E-5)

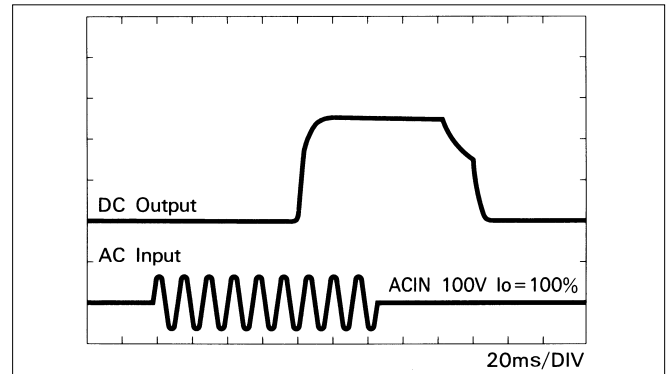

■ OVERCURRENT CHARACTERISTICS (P150E-5)

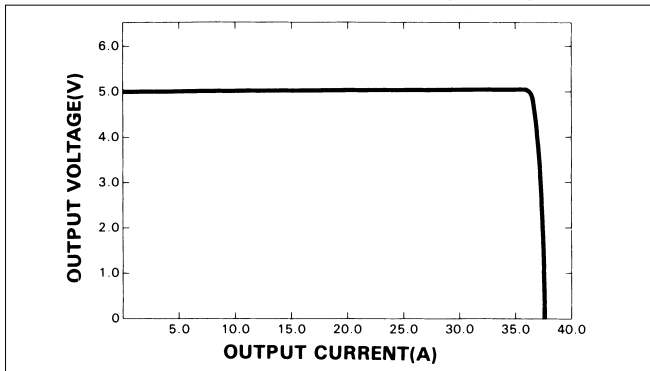

■ DERATING CURVE

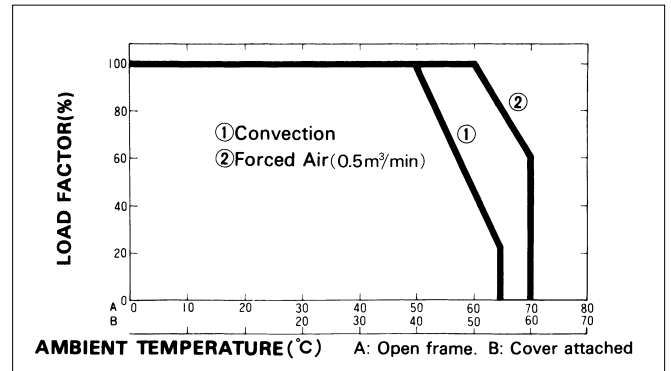



RoHS : Please consult us for details

- ① Series name
- ② Output wattage
- ③ UL recognized, TÜV approved, CSA certified: E
- ④ Output voltage
- ⑤ Optional
C : with Coating
G : Low leakage current
R : Positive logic control

MODEL	P300E-5	P300E-12	P300E-15	P300E-18	P300E-24	P300E-30	P300E-48
MAX OUTPUT WATTAGE[W]	300	324	330	306	336	300	312
DC OUTPUT	5V 60A	12V 27A	15V 22A	18V 17A	24V 14A	30V 10A	48V 6.5A

SPECIFICATIONS

	MODEL	P300E-5	P300E-12	P300E-15	P300E-18	P300E-24	P300E-30	P300E-48	
INPUT	VOLTAGE[V]	AC85 - 132 / 170 - 264 1φ (Auto-selectable)							
	CURRENT[A]	ACIN 100V *1	5.5typ (Io=100%)						
		ACIN 200V *1	3.5typ (Io=100%)						
	FREQUENCY[Hz]	47 - 63							
	EFFICIENCY[%]		74typ	78typ	81typ	81typ	83typ	78typ	79typ
	INRUSH CURRENT[A]	ACIN 100V	25/40typ (Io=100%) (Primary inrush current /Secondary inrush current)						
ACIN 200V		50/40typ (Io=100%) (Primary inrush current /Secondary inrush current)							
OUTPUT	VOLTAGE[V]	5	12	15	18	24	30	48	
	CURRENT[A]	60	27	22	17	14	10	6.5	
	MAX OUTPUT WATTAGE[W]	300	324	330	306	336	300	312	
	LINE REGULATION[mV]	20max	48max	60max	72max	96max	120max	192max	
	LOAD REGULATION[mV]	40max	100max	120max	144max	150max	180max	300max	
	RIPPLE[mVp-p] *2	80max	120max	120max	120max	120max	120max	150max	
	RIPPLE NOISE[mVp-p] *2	120max	150max	150max	150max	150max	200max	400max	
	TEMPERATURE REGULATION[mV]	0 to +50°C	50max	120max	150max	180max	240max	300max	480max
	OUTPUT VOLTAGE ADJUSTMENT RANGE[V]	± 10%							
	START-UP TIME[ms]	300max (ACIN 85/170V, Io=100%)							
HOLD-UP TIME[ms]	20typ (ACIN 85/170V, Io=100%) 40typ (ACIN 100/200V, Io=100%)								
PROTECTION CIRCUIT	OVERCURRENT PROTECTION	Works over 105% of rating and recovers automatically							
	OVERVOLTAGE PROTECTION	Works at 115 - 140% of rating							
ISOLATION	INPUT-OUTPUT · RC	AC3,000V 1minute, Cutoff current = 10mA, DC500V 50MΩmin (At Room Temperature)							
	INPUT-FG	AC2,000V 1minute, Cutoff current = 10mA, DC500V 50MΩmin (At Room Temperature)							
	OUTPUT · RC-FG	AC500V 1minute, Cutoff current = 100mA, DC500V 50MΩmin (At Room Temperature)							
	OUTPUT-RC	AC100V 1minute, Cutoff current = 100mA, DC100V 50MΩmin (At Room Temperature)							
ENVIRONMENT	OPERATING TEMP., HUMID. AND ALTITUDE	-10 to +60°C, 20 - 95%RH (Non condensing) (Refer to DERATING CURVE), 3,000m (10,000feet) max							
	STORAGE TEMP., HUMID. AND ALTITUDE	-20 to +75°C, 20 - 95%RH (Non condensing), 9,000m (30,000feet) max							
	VIBRATION	10 - 55Hz, 19.6m/s ² (2G), 3minutes period, 30minutes each along X, Y and Z axis							
	IMPACT	196.1m/s ² (20G), 11ms, once each X, Y and Z axis							
SAFETY AND NOISE REGULATIONS	AGENCY APPROVALS	UL60950-1, EN60950-1, EN50178, CSA C22.2 No.234 Complies with DEN-AN and IEC60950-1							
	CONDUCTED NOISE	Complies with FCC-A							

*1 The input current of the agency approved unit is indicated as 6.5A (ACIN 100V) or 3.6A (ACIN 200V).
 *2 According to 15MHz oscilloscope or Ripple-Noise meter (equivalent to KEISOKU-GIKEN : RM101).

External view

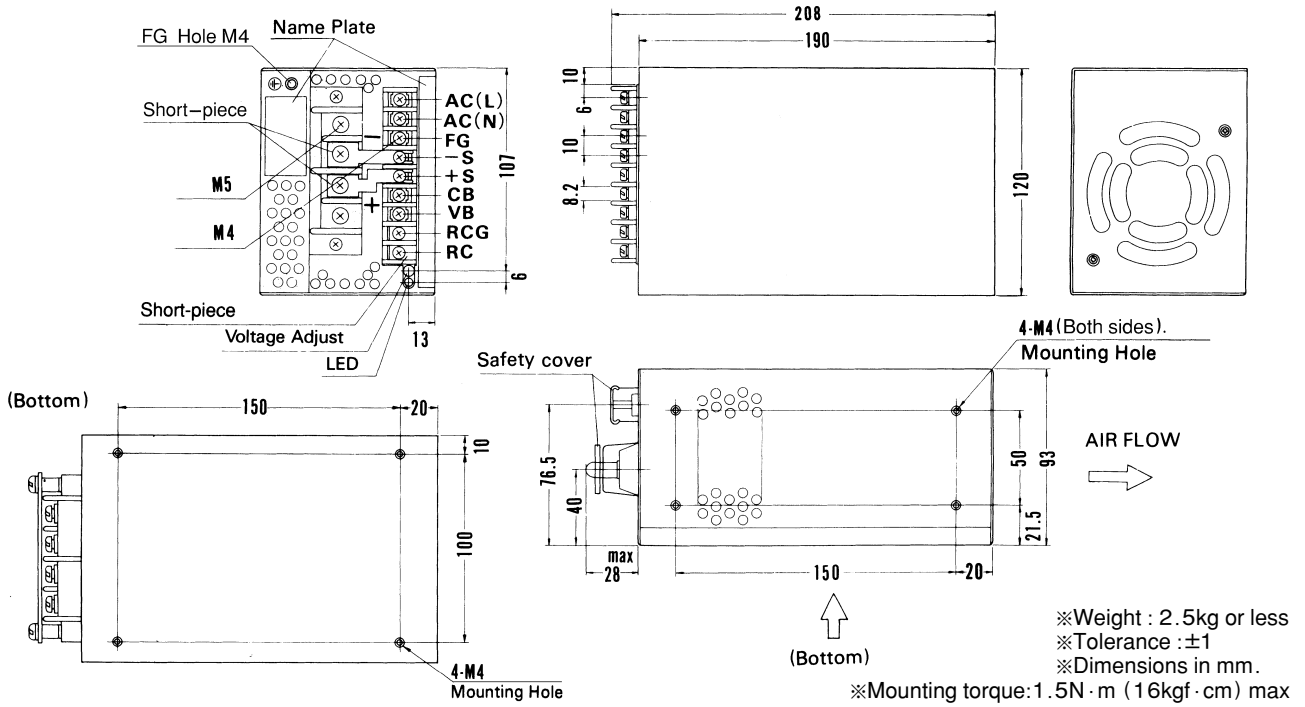

Performance data

■ Automatic Input Voltage Selector

Requires no manual adjustment (wire or Short-pieces). P300 unit detects input voltage then select circuit to match applied input voltage.

■ Automatic Current sharing

- Output voltage is controlled by a potentiometer in master unit. Turn slave unit's potentiometer clock wise all the way to the end.
- Maximum output current can be determined by using the following formula: Total output current = 0.9 × (Rated current per unit) × Number of units paralleled
- Five units maximum for the parallel operation.

● Example

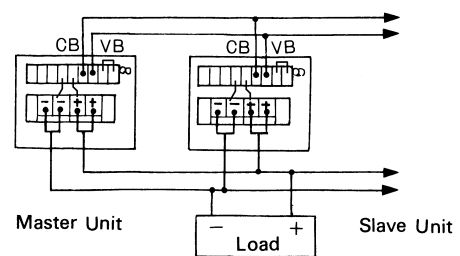

■ DERATING CURVE

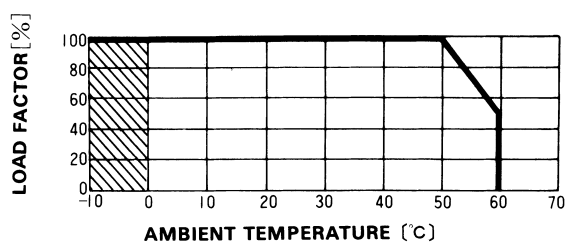

* The shadow indicates the region where different specifications for ripple noise should be used.



RoHS : Please consult us for details

- ① Series name
- ② Output wattage
- ③ UL recognized, TÜV approved, CSA certified: E
- ④ Output voltage
- ⑤ Optional
 C : with Coating
 G : Low leakage current
 R : Positive logic control

MODEL	P600E-5	P600E-12	P600E-15	P600E-18	P600E-24	P600E-30	P600E-48
MAX OUTPUT WATTAGE[W]	600	636	645	612	648	600	624
DC OUTPUT	5V 120A	12V 53A	15V 43A	18V 34A	24V 27A	30V 20A	48V 13A

SPECIFICATIONS

	MODEL	P600E-5	P600E-12	P600E-15	P600E-18	P600E-24	P600E-30	P600E-48	
INPUT	VOLTAGE[V]	AC85 - 132 / 170 - 264 1φ (Auto-selectable)							
	CURRENT[A]	ACIN 100V *1	11typ (Io=100%)						
		ACIN 200V *1	6typ (Io=100%)						
	FREQUENCY[Hz]	47 - 63							
	EFFICIENCY[%]		77typ	80typ	81typ	80typ	84typ	81typ	80typ
	INRUSH CURRENT[A]	ACIN 100V	30/50typ (Io=100%) (Primary inrush current /Secondary inrush current)						
ACIN 200V		60/50typ (Io=100%) (Primary inrush current /Secondary inrush current)							
OUTPUT	VOLTAGE[V]	5	12	15	18	24	30	48	
	CURRENT[A]	120	53	43	34	27	20	13	
	MAX OUTPUT WATTAGE[W]	600	636	645	612	648	600	624	
	LINE REGULATION[mV]	20max	48max	60max	72max	96max	120max	192max	
	LOAD REGULATION[mV]	40max	100max	120max	144max	150max	180max	300max	
	RIPPLE[mVp-p] *2	80max	120max	120max	120max	120max	150max	150max	
	RIPPLE NOISE[mVp-p] *2	120max	150max	150max	150max	150max	200max	400max	
	TEMPERATURE REGULATION[mV] 0 to +50°C	50max	120max	150max	180max	240max	300max	480max	
	OUTPUT VOLTAGE ADJUSTMENT RANGE[V]	± 10%							
	START-UP TIME[ms]	300max (ACIN 85/170V, Io=100%)							
HOLD-UP TIME[ms]	20typ (ACIN 85/170V, Io=100%)								
PROTECTION CIRCUIT	OVERCURRENT PROTECTION	Works over 105% of rating and recovers automatically							
	OVERVOLTAGE PROTECTION	Works at 115 - 140% of rating							
ISOLATION	INPUT-OUTPUT · RC	AC3,000V 1minute, Cutoff current = 10mA, DC500V 50MΩmin (At Room Temperature)							
	INPUT-FG	AC2,000V 1minute, Cutoff current = 10mA, DC500V 50MΩmin (At Room Temperature)							
	OUTPUT · RC-FG	AC500V 1minute, Cutoff current = 100mA, DC500V 50MΩmin (At Room Temperature)							
	OUTPUT-RC	AC100V 1minute, Cutoff current = 100mA, DC100V 50MΩmin (At Room Temperature)							
ENVIRONMENT	OPERATING TEMP., HUMID. AND ALTITUDE	0 to +60°C, 30 - 90%RH (Non condensing) (Refer to DERATING CURVE), 3,000m (10,000feet) max							
	STORAGE TEMP., HUMID. AND ALTITUDE	-20 to +75°C, 20 - 90%RH (Non condensing), 9,000m (30,000feet) max							
	VIBRATION	10 - 55Hz, 19.6m/s ² (2G), 3minutes period, 30minutes each along X, Y and Z axis							
	IMPACT	196.1m/s ² (20G), 11ms, once each X, Y and Z axis							
SAFETY AND NOISE REGULATIONS	AGENCY APPROVALS	UL60950-1, EN60950-1, EN50178, CSA C22.2 No.234 Complies with DEN-AN and IEC60950-1							
	CONDUCTED NOISE	Complies with FCC-A							

*1 The input current of the agency approved unit is indicated as 11.6A (ACIN 100V) or 6.2A (ACIN 200V).
 *2 According to 15MHz oscilloscope or Ripple-Noise meter (equivalent to KEISOKU-GIKEN : RM101).

External view

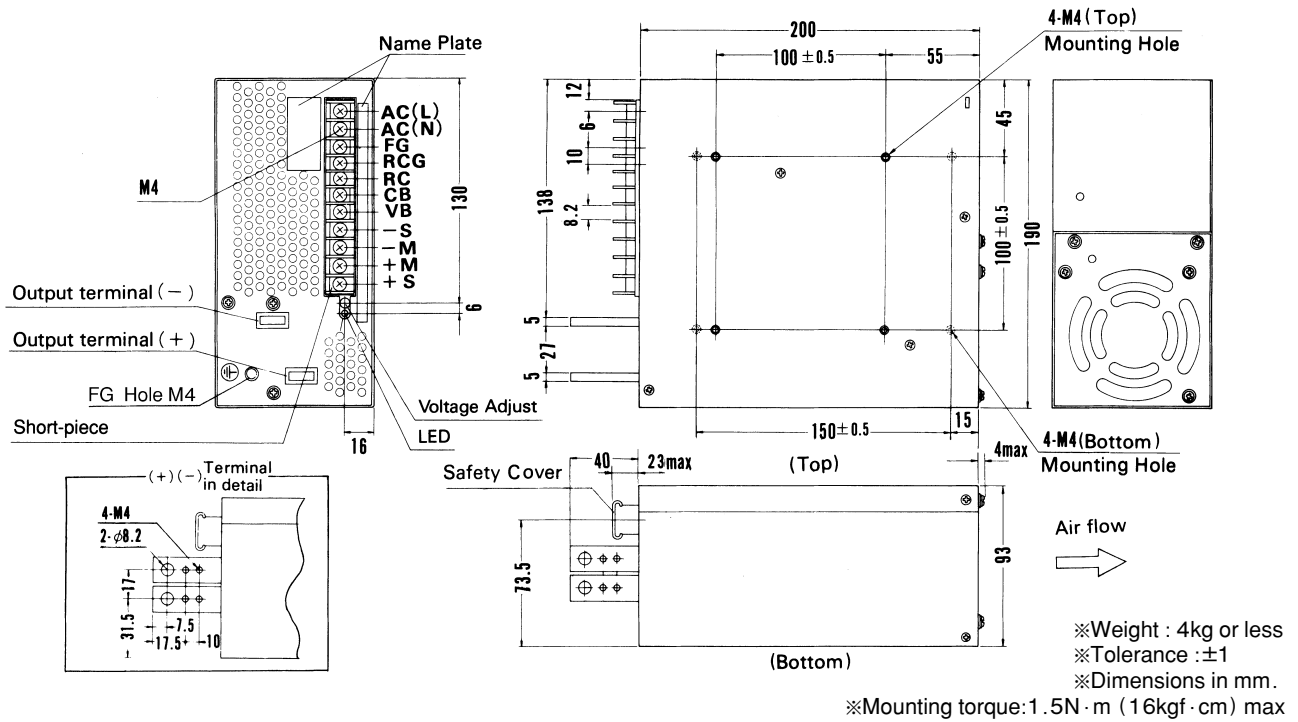

Performance data

Automatic Input Voltage Selector

Requires no manual adjustment (wire or Short-pieces). P600 unit detects input voltage then select circuit to match applied input voltage.

Automatic Current sharing

- Output voltage is controlled by a potentiometer in master unit. Turn slave unit's potentiometer clock wise all the way to the end.
- Maximun output current can be determined by using the following formula: Total output current = 0.9 × (Rated current per unit) × Number of units paralleled
- Five units maximum for the parallel operation.

Example

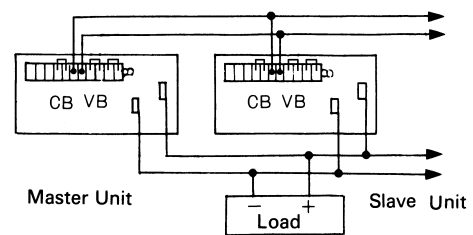

DERATING CURVE

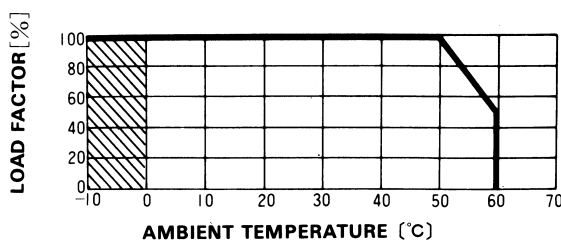

* The shadow indicates the region where different specifications for ripple noise should be used.

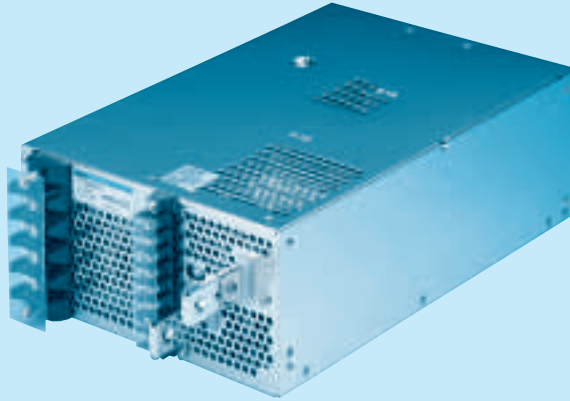

RoHS : Please consult us for details

- ① Series name
- ② Output wattage
- ③ UL recognized, TÜV approved, CSA certified: E
- ④ Output voltage
- ⑤ Optional
C : with Coating

MODEL	P1500E-5	P1500E-12	P1500E-15	P1500E-18	P1500E-24
MAX OUTPUT WATTAGE[W]	1500	1500	1500	1512	1560
DC OUTPUT	5V 300A	12V 125A	15V 100A	18V 84A	24V 65A

SPECIFICATIONS

	MODEL	P1500E-5	P1500E-12	P1500E-15	P1500E-18	P1500E-24	
INPUT	VOLTAGE[V]	AC85 - 132 / 170 - 264 1φ (User-selectable) or DC220 - 370					
	CURRENT[A]	ACIN 100V *1	29typ (Io=100%)				
		ACIN 200V *1	18typ (Io=100%)				
	FREQUENCY[Hz]	47 - 440					
	EFFICIENCY[%]		78typ	81typ	81typ	81typ	83typ
	INRUSH CURRENT[A]	ACIN 100V	25/150typ (Io=100%) (Primary inrush current /Secondary inrush current)				
ACIN 200V		50/150typ (Io=100%) (Primary inrush current /Secondary inrush current)					
OUTPUT	VOLTAGE[V]	5	12	15	18	24	
	CURRENT[A]	300	125	100	84	65	
	MAX OUTPUT WATTAGE[W]	1500	1500	1500	1512	1560	
	LINE REGULATION[mV]	20max	48max	60max	72max	96max	
	LOAD REGULATION[mV]	40max	100max	120max	150max	150max	
	RIPPLE[mVp-p] *2	80max	120max	120max	120max	120max	
	RIPPLE NOISE[mVp-p] *2	120max	150max	150max	150max	150max	
	TEMPERATURE REGULATION[mV] 0 to +50°C	50max	120max	150max	180max	240max	
	OUTPUT VOLTAGE ADJUSTMENT RANGE[V]	-20 to +10%					
	START-UP TIME[ms]	800max (ACIN 85/170V, Io=100%)					
HOLD-UP TIME[ms]	10typ (ACIN 85/170V, Io=100%) 20typ (ACIN 100/200V, Io=100%)						
PROTECTION CIRCUIT	OVERCURRENT PROTECTION	Works over 105% of rating					
	OVERVOLTAGE PROTECTION	Works at 115 - 140% of rating					
ISOLATION	INPUT-OUTPUT · RC	AC3,000V 1minute, Cutoff current = 10mA, DC500V 50MΩmin (At Room Temperature)					
	INPUT-FG	AC2,000V 1minute, Cutoff current = 10mA, DC500V 50MΩmin (At Room Temperature)					
	OUTPUT · RC-FG	AC500V 1minute, Cutoff current = 100mA, DC500V 50MΩmin (At Room Temperature)					
	OUTPUT-RC	AC100V 1minute, Cutoff current = 100mA, DC100V 50MΩmin (At Room Temperature)					
ENVIRONMENT	OPERATING TEMP., HUMID. AND ALTITUDE	-10 to +60°C, 30 - 90%RH (Non condensing) (Refer to DERATING CURVE), 3,000m (10,000feet) max					
	STORAGE TEMP., HUMID. AND ALTITUDE	-20 to +75°C, 20 - 90%RH (Non condensing), 9,000m (30,000feet) max					
	VIBRATION	10 - 55Hz, 19.6m/s ² (2G), 3minutes period, 30minutes each along X, Y and Z axis					
	IMPACT	196.1m/s ² (20G), 11ms, once each X, Y and Z axis					
SAFETY AND NOISE REGULATIONS	AGENCY APPROVALS	UL60950-1, EN60950-1, EN50178, CSA C22.2 No.234 Complies with DEN-AN and IEC60950-1					
	CONDUCTED NOISE	Complies with FCC-A					

*1 The input current of the agency approved unit is indicated as 27A (ACIN 100V) or 17A (ACIN 200V).

*2 According to 15MHz oscilloscope or Ripple-Noise meter (equivalent to KEISOKU-GIKEN : RM101).

External view

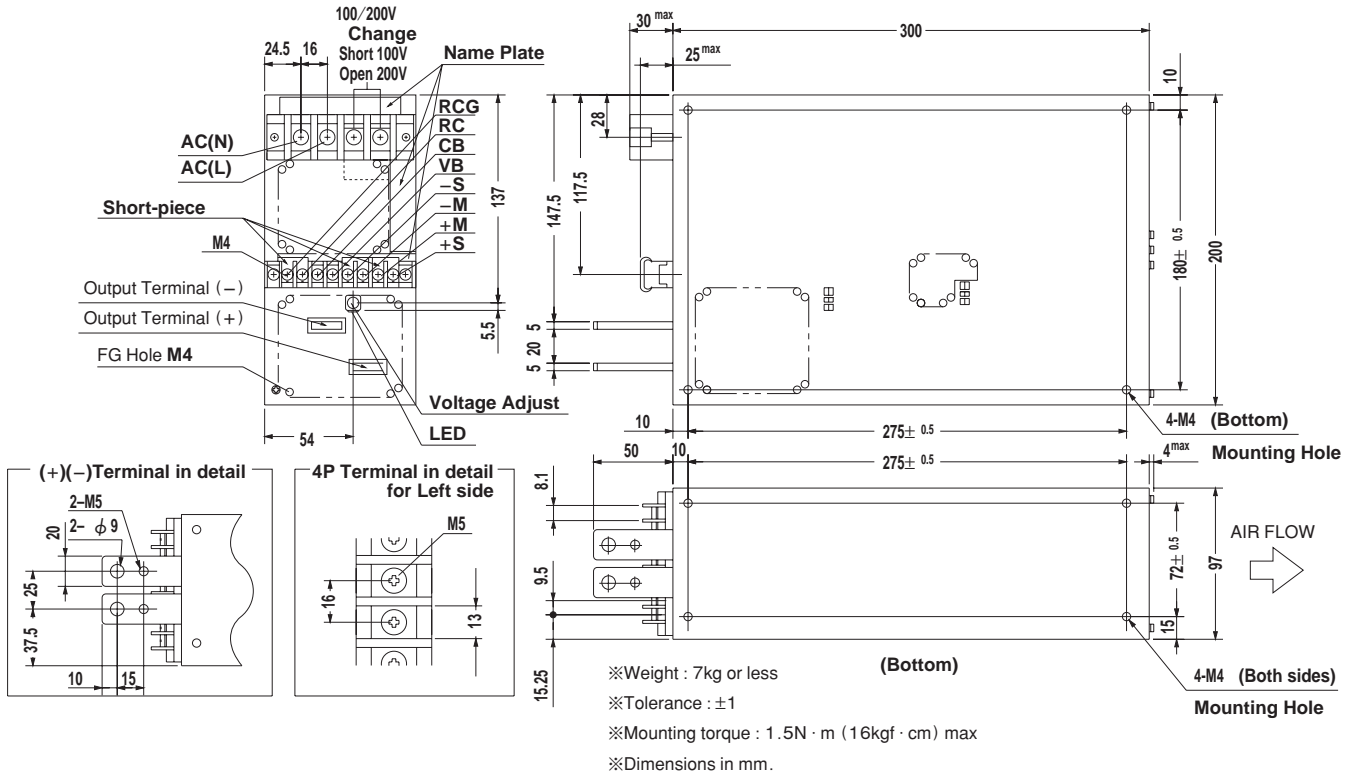

Performance data

Automatic Current sharing

- Output voltage is controlled by a potentiometer in master unit. Turn slave unit's potentiometer clock wise all the way to the end.
- Maximum output current can be determined by using the following formula: Total output current = 0.9 × (Rated current per unit) × Number of units paralleled
- Five units maximum for the parallel operation.

EXAMPLE

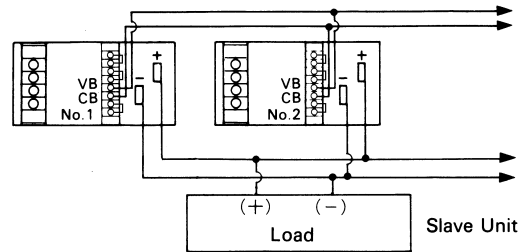

DERATING CURVE

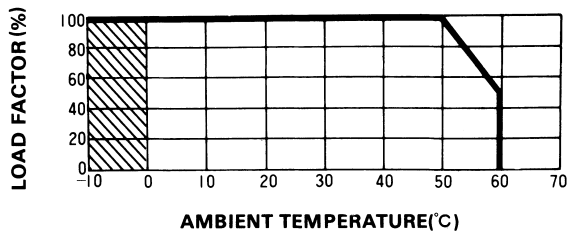

* The shadow indicates the region where different specifications for ripple noise should be used.

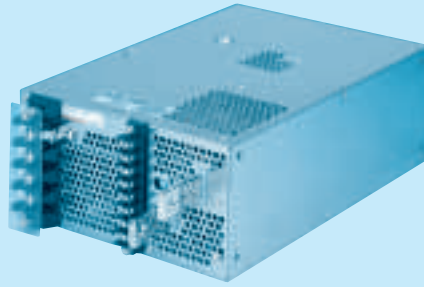

- ① Series name
- ② Triple input phase
- ③ Output wattage
- ④ UL recognized, CSA certified: U
- ⑤ Output voltage
- ⑧ Optional
C : with Coating

RoHS : Please consult us for details

MODEL	PT1500U-5	PT1500U-24
OUTPUT VOLTAGE[V]	5	24
OUTPUT CURRENT[A]	300	65

SPECIFICATIONS

	MODEL	PT1500U-5	PT1500U-24	
INPUT	VOLTAGE[V]	AC170 - 264 3 φ		
	CURRENT[A]	ACIN 200V	6typ (Io=100%)	
	FREQUENCY[Hz]	47 - 63		
	EFFICIENCY[%]	80typ		
	POWER FACTOR	ACIN 200V	0.95typ (Io=100%)	
	INRUSH CURRENT[A]	ACIN 200V	40typ	
	LEAKAGE CURRENT[mA]	0.75max (60Hz by UL, CSA standards) / 1.0max (60Hz by DEN-AN)		
OUTPUT	VOLTAGE[V]	5	24	
	CURRENT[A]	300	65	
	MAX OUTPUT WATTAGE[W]	1500	1560	
	LINE REGULATION[mV]	20max	96max	
	LOAD REGULATION[mV]	40max	150max	
	RIPPLE[mVp-p]	0 to +50°C *2	80max	120max
		-10 - 0°C *2	140max	160max
	RIPPLE NOISE[mVp-p]	0 to +50°C *2	120max	150max
		-10 - 0°C *2	160max	180max
	TEMPERATURE REGULATION[mV]	0 to +50°C	50max	240max
	DRIFT[mV]	*1	20max	96max
START-UP TIME[ms]	800max (ACIN 170V, Io=100%)			
HOLD-UP TIME[ms]	20typ (ACIN 200V, Io=100%, 0 to +50°C) 10typ (ACIN 170V, Io=100%, 0 to +50°C)			
OUTPUT VOLTAGE ADJUSTMENT RANGE[V]	4.00 - 5.50	19.20 - 26.40		
PROTECTION CIRCUIT	OVERCURRENT PROTECTION	Works over 105% of rating		
	OVERVOLTAGE PROTECTION	Works at 115 - 140% of rating		
	OPERATING INDICATION	LED (Green)		
	REMOTE SENSING	Provided		
	REMOTE ON/OFF	Provided (isolated from output)		
ISOLATION	INPUT-OUTPUT	AC3,000V 1minute, Cutoff current = 10mA, DC500V 50MΩmin (At Room Temperature)		
	INPUT-FG	AC1,500V 1minute, Cutoff current = 10mA, DC500V 50MΩmin (At Room Temperature)		
	OUTPUT-FG, COVER	AC500V 1minute, Cutoff current = 100mA, DC500V 50MΩmin (At Room Temperature)		
	OUTPUT-RC	AC100V 1minute, Cutoff current = 100mA, DC100V 50MΩmin (At Room Temperature)		
ENVIRONMENT	OPERATING TEMP., HUMID. AND ALTITUDE	-10 to +50°C (Refer to DERATING CURVE), 3,000m (10,000feet) max		
	STORAGE TEMP., HUMID. AND ALTITUDE	-20 to +75°C, 9,000m (30,000feet) max		
	VIBRATION	10 - 55Hz, 19.6m/s ² (2G), 3minutes period, 60minutes each along X, Y and Z axis		
	IMPACT	196.1m/s ² (20G), 11ms, once each X, Y and Z axis		
SAFETY AND NOISE REGULATIONS	AGENCY APPROVALS	UL60950-1, CSA C22.2 No.234 Complies with DEN-AN		
	CONDUCTED NOISE	Complies with FCC-A		

*1 Drift is change in DC output for an eight hour period after a half-hour warm-up at 25°C, with the input voltage held constant at the rated input/output.
 *2 According to 20MHz oscilloscope or Ripple-Noise meter (equivalent to KEISOKU-GIKEN : RM101).

External view

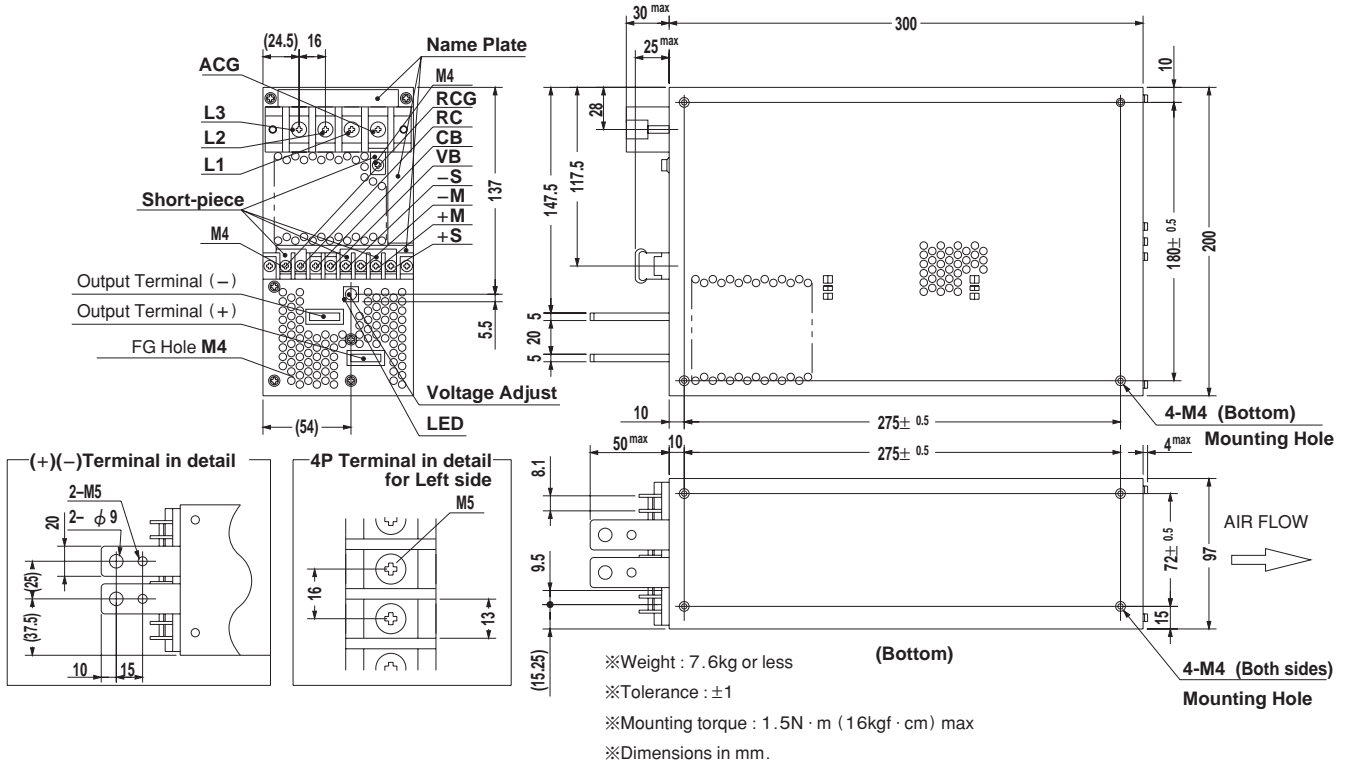

Performance data

Automatic Current sharing

- Output voltage is controlled by the Output Voltage Adjuster in Master unit. Turn Slave unit's Output Voltage Potentiometer clockwise all the end.
- Maximum output current can be determined by using the following formula: Total output current = 0.9 × (Rated current per unit) × Number of units paralleled
- Five units maximum for the parallel operation.

EXAMPLE

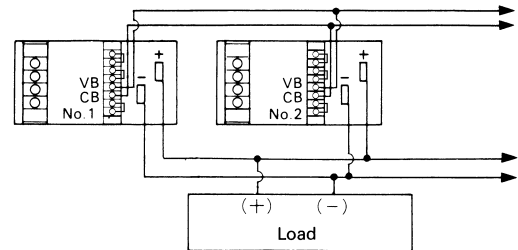

DERATING CURVE

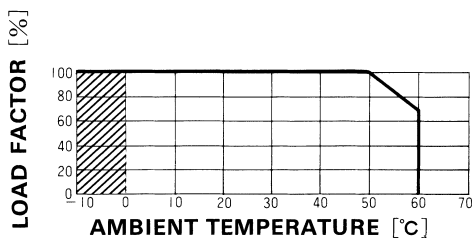

* The shadow indicates the region where different specifications on ripple and ripple noise should be used.